

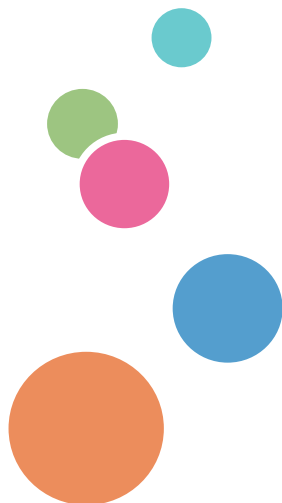

User's Manual

Usage Notice	1
Introduction	2
Basic Operations	3
User Settings	4
Troubleshooting	5
Appendices	6



Read this manual carefully before you use this machine and keep it handy for future reference. For safe and correct use, be sure to read the Precautions in this manual before using the machine.

Table of Contents

Table of Contents	1	<i>Main Menu</i>	27
Usage Notice	2	<i>Image Menu</i>	29
<i>Precautions</i>	2	<i>Display</i>	31
<i>Safety Labels of This Machine</i>	6	<i>Setup</i>	32
<i>Other Information</i>	7	<i>WiFi Setting</i>	34
Introduction	8	<i>User Logo Setting</i>	37
<i>Product Features</i>	8	Troubleshooting	43
<i>Package Overview</i>	9	Appendices	47
<i>Product Overview</i>	10	<i>List of Compatible Signals</i>	47
<i>Connection Ports</i>	11	<i>Specifications</i>	50
<i>Control Panel</i>	12	<i>Dispose of the Projector</i>	51
<i>360° Installation</i>	13	<i>Cabinet Dimensions</i>	54
<i>Attaching a Wrist Strap</i>	14	<i>Trademarks</i>	55
Basic Operations	15	<i>Copyrights</i>	56
<i>Connecting the Projector</i>	15		
<i>Charging the Projector</i>	15		
<i>Connect to Video/PC/iOS/Android</i>	16		
<i>Powering On/Off the Projector</i>	17		
<i>Powering On the Projector and</i> <i>Connecting to the HDMI Source</i>	17		
<i>Powering On the Projector and</i> <i>Connecting to the iOS Device (Direct</i> <i>Connection)</i>	18		
<i>Powering On the Projector and</i> <i>Connecting to the iOS Device (Connection</i> <i>via Router)</i>	19		
<i>Powering On the Projector and</i> <i>Connecting to the Android Device</i> <i>(Direct Connection)</i>	20		
<i>Powering Off the Projector</i>	21		
<i>Warning Indicator</i>	21		
<i>Adjusting the Projector Focus</i>	23		
<i>Adjusting Projection Image Size</i>	23		
User Settings	24		
<i>On Screen Display (OSD)</i>	24		
<i>How to operate</i>	24		
<i>Menu Tree</i>	25		

Usage Notice

Precautions



Follow all warnings, precautions and maintenance as recommended in this user's guide to maximize the life of your unit.

- **Warning-** **Indicates a potentially hazardous situation which, if instructions are not followed, could result in death or serious injury.**

- **Caution-** **Indicates a potentially hazardous situation which, if instructions are not followed, may result in minor or moderate injury or damage to property.**

- **Warning-** Do not use flammable sprays or solvents in the vicinity of this machine. Also, avoid placing these items in the vicinity of this machine. Doing so could result in fire or electric shock.
- **Warning-** Do not place vases, plant pots, cups, toiletries, medicines, small metal objects, or containers holding water or any other liquids, on or close to this machine. Fire or electric shock could result from spillage or if such objects or substances fall inside this machine.
- **Warning-** Keep the machine and attachments out of the reach of children. If the machine is near children, it may cause injury.
- **Warning-** Plastic bags can be dangerous, please do not leave near babies and young children. To avoid the threat of suffocation, please keep away from their nose and mouth.
- **Warning-** Do not use the connection cable if it is deformed, cracked, or damaged. Doing so could result in fire or electric shock. If the connection cable is deformed, cracked, or damaged, contact your service representative to request a replacement cable.
- **Warning-** When using an extension cord or power strip, only connect equipment whose total power consumption is within the power rating for the extension cord or power strip. If the power rating is exceeded, it may cause heat buildup and result in fire.

Usage Notice

- Warning- If the machine emits smoke or odours, or if it behaves unusually, you must turn off its power immediately. After turning off the power, be sure to disconnect the power adapter from the machine. Then contact your service representative and report the problem. Do not use the machine. Doing so could result in fire or electric shock.
- Warning- If metal objects, or water or other fluids fall inside this machine, you must turn off its power immediately. After turning off the power, be sure to disconnect the power adapter from the machine. Then contact your service representative and report the problem. Do not use the machine. Doing so could result in fire or electric shock.
- Warning- If the machine topples, or if a cover or other part gets broken, you must turn off its power immediately. After turning off the power, be sure to disconnect the power adapter from the machine. Then contact your service representative and report the problem. Do not use the machine. Doing so could result in fire or electric shock.
- Warning- Never push objects of any kind into this product through openings as they may touch dangerous voltage points or short-out parts that could result in a fire or electric shock. Never spill liquid of any kind on the product.
- Warning- Do not remove any covers or screws that are not mentioned in this manual. There are high voltage components inside the machine that may cause electric shock. Contact your service representative if any of the machine's internal components require maintenance, adjustment, or repair.
- Warning- Do not disassemble or modify the machine. Doing so may cause injury or malfunction.
- Warning- Do not install the projector on a wall or ceiling.
- Caution- Keep the machine away from humidity and dust. Otherwise a fire or an electric shock might occur.
- Caution- Do not place any objects on the machine. Doing so may cause the machine to topple over, possibly resulting in injury.
- Caution- Do not place the machine on an unstable or tilted surface. If it topples over, an injury might occur.

Usage Notice

- Caution- Do not place the machine or use it in an environment where it might get wet such as from snow, rain, or being near water. Doing so could result in fire or electric shock.
- Caution- Do not place the machine in a location where air flow is poor. Doing so may cause fire due to internal components becoming overheated.
- Caution- Do not place or store the machine in a location where direct sunlight or heat generation might occur. The heat may deform or wear out the exterior parts or negatively affect internal parts. Doing so could result in fire.
- Caution- If this machine is not going to be used for several days or longer at a time, disconnect the machine from the power adapter.
- Caution- When performing maintenance on the machine, always disconnect the machine from the power adapter.
- Caution- Do not place the machine on other equipment or vice versa. Doing so may cause heat buildup inside the machine or cause the other equipment to malfunction.
- Caution- Do not increase the volume unless you are listening while increasing the volume. Also, lower the volume before turning off the power, because a loud sound may be emitted when the power is turned on and cause hearing damage.
- Caution- If the machine's interior is not cleaned regularly, dust will accumulate. Fire and breakdown can result from heavy accumulation of dust inside this machine. Contact your sales or service representative for details about and charges for cleaning the machine's interior.
- Caution- Unplug this product from the power adapter and take the product to qualified service personnel if you encounter any of the following conditions:
 - a) Liquid has been spilled, or objects have fallen into the product.
 - b) The product has been exposed to rain or water.
 - c) The product does not operate normally when following the operating instructions. Adjust only those controls that are covered by the operating instructions.
 - d) The product has been dropped or damaged in any way. (If the cabinet should break, please handle with care to avoid injury.)

Usage Notice

- Caution- This product incorporates glass components, including a lens. If these should break, please handle with care to avoid injury and contact your sales representative for repair service. Avoid any broken pieces of glass since they may cause injury. In the unlikely event that the light source ruptures, thoroughly clean the area around the projector and discard any edible items placed in that area since they may be contaminated.
- Caution- Unauthorized substitutions may result in fire, electric shock, or other hazards. (Only the replacement of the light source should be made by users.)
Upon completion of any service or repairs to this product, ask the service technician to perform safety checks to verify that the product is in proper operating condition.
- Caution- Do not use the product in a closed installation location. Do not place the product in a box or in any other closed installation location. Otherwise it may overheat, which could result in a risk of fire.

Important:

Contents of this manual are subject to change without prior notice. In no event will the company be liable for direct, indirect, special, incidental, or consequential damages as a result of handling or operating this product.

Safety Labels of This Machine

Do not look into the lens while the LED light source is on. The strong light from the LED light source may cause damage to your eyesight.

If you wish to discard this product, please contact your local authorities, the shop where you bought this product, your local dealer or sales/service representatives.

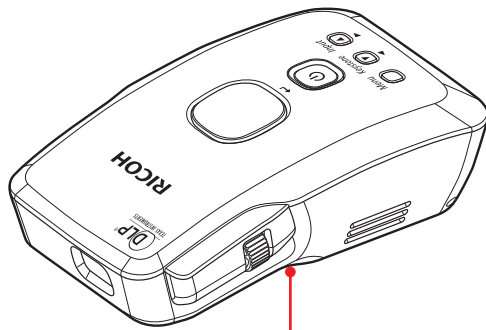

Power Switch Symbols

The meaning of the symbols for the switches on this machine as follows:

: On/Standby (Off)

Other Information

Copyrights to Images

When projecting images using the projector, be careful not to infringe the copyright of protected materials. The following are examples that may infringe the copyright of protected materials.

- Broadcasting images or movies for commercial purposes
- Modifying images or movies using functions such as freeze, magnify, or zoom to broadcast images for commercial purposes or public viewing
- Varying the aspect ratio of images or movies using a function that changes the screen size to broadcast images for commercial purposes or public viewing

Product Features

Outstanding features include:

- FWVGA (854x480)
- Single chip DLP® technology
- SDTV(480i/576i), EDTV(480p/576p),
HDTV(720p/1080i/1080p) compatible
- LED light source, 20000H life
- User friendly multilingual on screen display (OSD)
- High quality full screen image re-scaling
- Built-in mono 1-Watt speaker.
- WXGA, SXGA+, SXGA, XGA compression
- Supports IEEE 802.11n/ac WiFi protocol

Introduction

Package Overview

This projector comes with all the items shown below. Check to make sure your unit is complete. Contact your dealer immediately if anything is missing.

Note

❖ Due to the difference in applications for each country, some regions may have different accessories and documents.

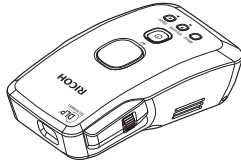

Projector

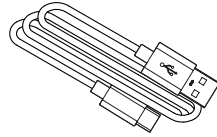

USB TypeA-C cable



Wrist strap



Pouch

Documentation:

Read This First

Introduction

Product Overview

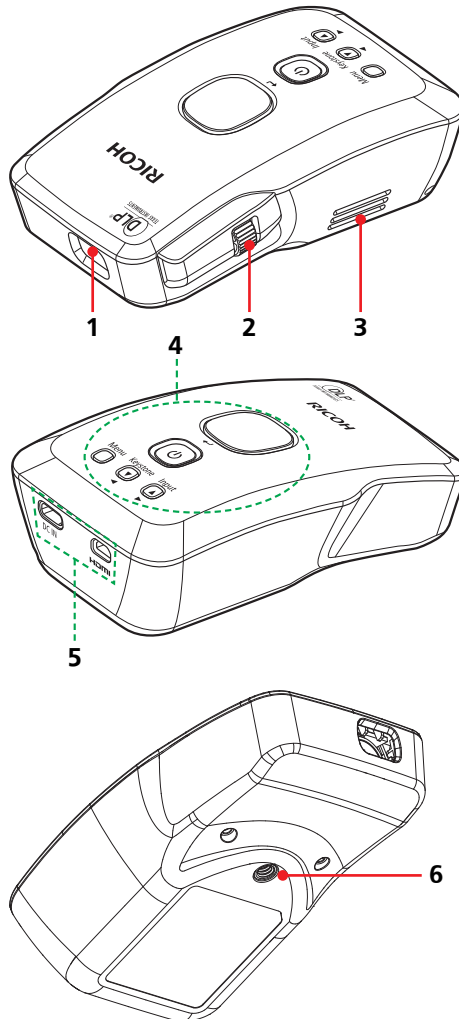

- | | |
|-----------------------|----------------------|
| 1. Lens | 4. Control panel |
| 2. Focus ring | 5. Connection ports |
| 3. Speaker (internal) | 6. Tripod screw hole |

Connection Ports

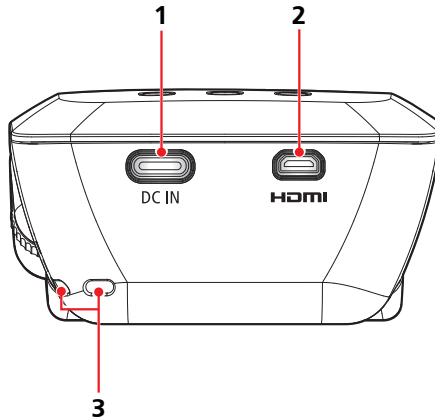

1. Type-C terminal (DC power input)
2. Micro HDMI terminal
3. Strap hole

Introduction

Control Panel

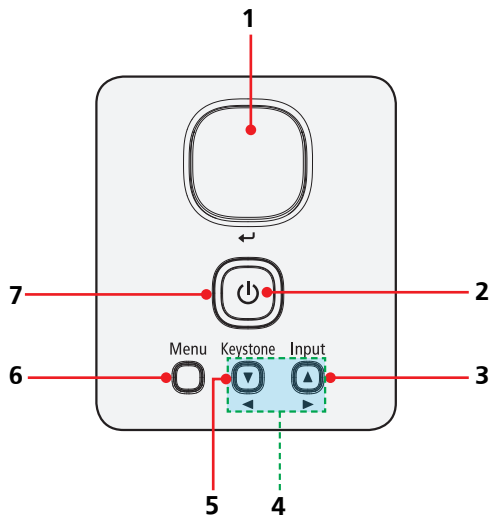

1	Display/Enter	Confirm your section of items in sub menu operation or start a presentation.
2	Power	Refer to the “Power On/Off the Projector” section. Please see pages 17~21.
3	Input	Select the input source.
4	Four Directional Select Keys	Use ▲, ▼, ◀, or ▶ to select items or make adjustments to your selection.
5	Keystone	Adjust the projector keystone.
6	Menu	Press the “Menu” key to launch the Onscreen display (OSD).
7	LED Indicator	Displays the status of this projector.

Introduction

360° Installation

This projector supports 360° free orientation operation.

- ▶ The projector must be installed in a location that is sturdy enough to support the full weight of the projector and brackets. (The weight of GP01 is approximately 0.20kg).
- ▶ Ensure that the projector is tightly secured to the brackets.

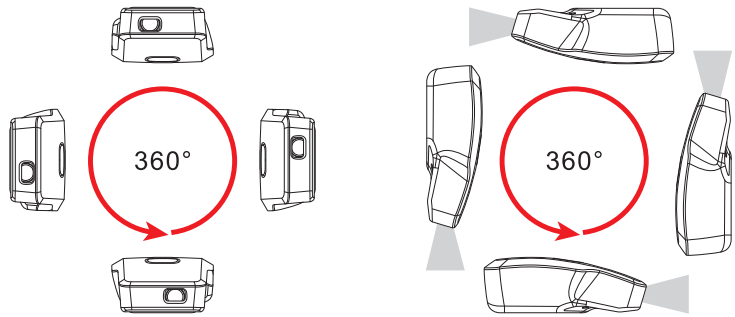

Basic Operations

Attaching a Wrist Strap

When projecting by hand, hang the projector around your wrist with a wrist strap.

To attach the wrist strap, follow steps 1 ~ 2.

Step 1:

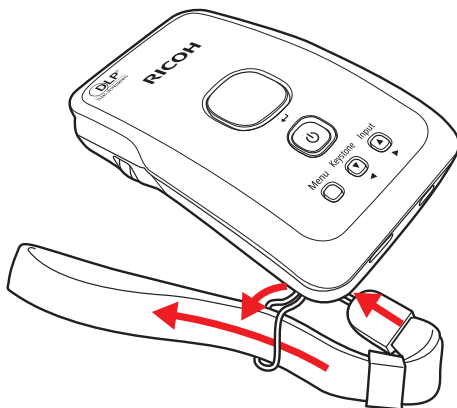

Step 2:

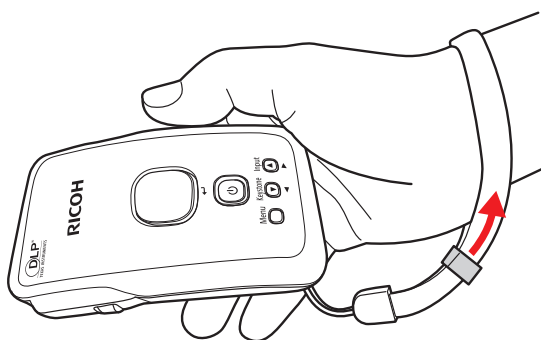

Note

❖ A wrist strap is effective in preventing projector dropping and avoiding possible damage to the product.

Connecting the Projector

Charging the Projector

Note

Fully charge the projector before using it for the first time.

- ❖ Ensure that the power adapter is firmly connected to the wall outlet.
- ❖ Ensure that the USB cable is firmly connected to the power adapter and to the DC IN port on the projector.
- ❖ Connect the power adapter to the wall outlet that is the closest to the projector.
- ❖ (*) The power adapter is an optional item and not supplied. Please use an adapter that has an output of 5V/2A or higher.

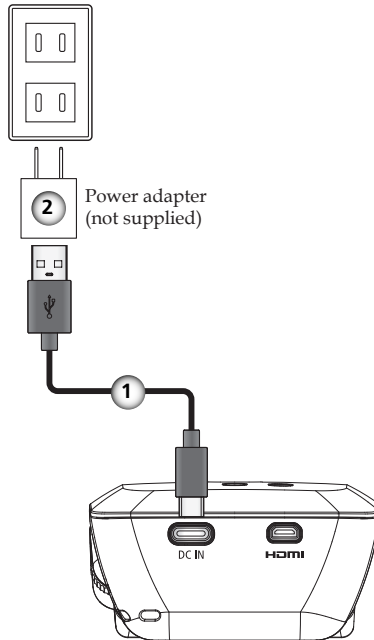

- 1..... USB-C to USB-A cable
- 2..... AC adapter(*)

- ❖ During projector's built-in battery charging, the LED indicator is flashing red.
- ❖ When the battery charging is complete, the LED indicator turns off.
- ❖ When the battery charging is complete, please unplug the AC adapter from the wall outlet.

Basic Operations

Connect to Video/PC/iOS/Android

Note

- ❖ Due to the difference in applications for each country, some regions may have different accessories.
- ❖ To ensure the projector works well with your computer, please make sure the timing of the display mode is compatible with your projector. Please see page 47.
- ❖ Use the cables that come with the projector.

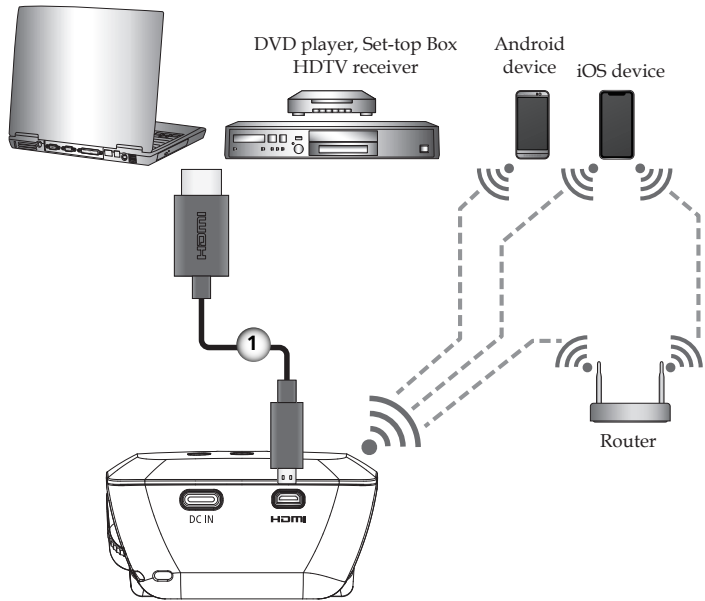

1..... HDMI Cable

Powering On/Off the Projector

Powering On the Projector and Connecting to the HDMI Source

Note

❖ If you turn on the projector for the first time, the system will display a language selection menu.

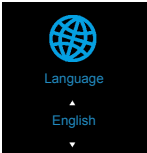

Select your preferred language and press the “Display/Enter” key on the control panel to confirm.

❖ To display the Input Source menu, press the “Power” key for 0.5 seconds or longer.

❖ Turn on the projector first and then the signal source.

1. Ensure that the HDMI cable is firmly connected. If using an external power supply, ensure that the USB-C cable is securely connected to the power adapter and power adapter is connected to the wall outlet.
2. Turn on the projector by pressing and holding the “Power” key for 1 second or longer. ❶
The power LED around the “Power” key will turn blue and the RICOH logo will be displayed on the screen for 20 seconds. After that is displayed a blank screen.
3. Turn on the HDMI source, for example Video Player.
4. Press the “Display/Enter” key to start the projection. By default, the screen is displayed while pressing the “Display/Enter” key.
5. If the projector cannot detect the source, it will display the source icon on the screen. Press the “Input” key to change the signal source or confirm the source.
6. Turn the focus ring to adjust the focus manually.

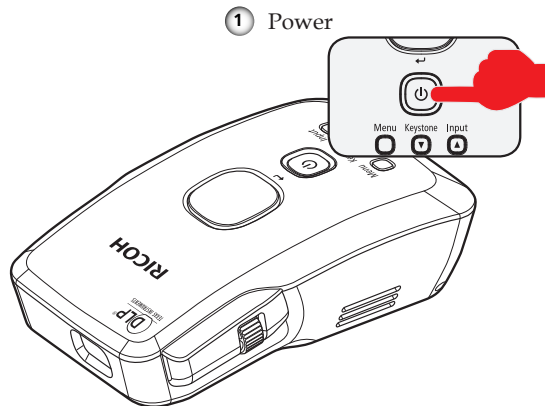

CAUTION:

- Do not look into the lens while the projector is on. The strong light from the light source may cause damage to your eyesight.
- Do not block the light from projection lens by anything when you want to stop projection. Doing so could cause a fire due to heating by strong light. Please use “Keep Projection” function for this purpose.

Basic Operations

Powering On the Projector and Connecting to the iOS Device (Direct Connection)

Note

❖ Press the “Input” key for 0.5 seconds or longer to display the Input Source menu.

❖ To learn how to use your iOS device, please refer to the operating instructions that came with the device.

1. Turn on the projector by pressing and holding the “Power” key for 1 second or longer.
The power LED around the “Power” key will turn blue and the RICOH logo will be displayed on the screen for 20 seconds. After that is displayed a blank screen.
2. Press the “Input” key for 0.5 seconds or longer to display the Input Source menu. Press the ▲/▼ keys to change the input source to iOS. Then press the “Display/Enter” key.
3. Press the “Display/Enter” key again to display the screen. If the connection to the iOS device has not been established, the Device Name and Password message will appear on the top left corner of the screen. (Figure 1)
4. Configure WiFi settings on the iOS device. Open the “Settings” > “WiFi” menu. Enable “WiFi”. Select the Device name that is displayed on the screen, and enter the password to establish the WiFi connection. (Figures 2~4)
5. Swipe up from the bottom of the iOS screen to open the Control Center. Tap on “Screen Mirroring”. (Figure 5)
6. Tap on the connected ImagePointer to start the screen mirroring. (Figure 6)

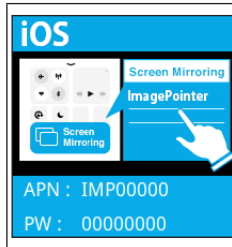

Figure 1

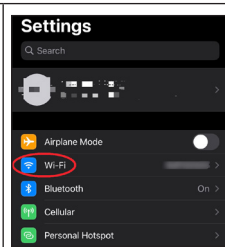

Figure 2

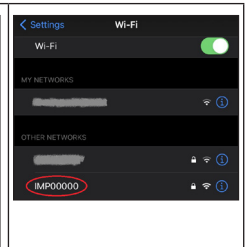

Figure 3

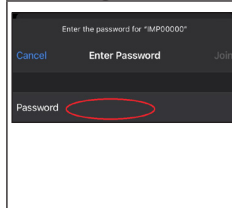

Figure 4

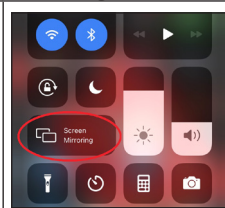

Figure 5

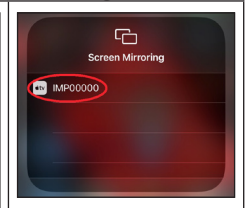

Figure 6

Powering On the Projector and Connecting to the iOS Device (Connection via Router)

Note

❖ Press the “Input” key for 0.5 seconds or longer to display the Input Source menu.

❖ To learn how to use your iOS device, please refer to the operating instructions that came with the device.

1. Turn on the projector by pressing and holding the “Power” key for 1 second or longer.
The power LED around the “Power” key will turn blue and the RICOH logo will be displayed on the screen for 20 seconds. After that is displayed a blank screen.
2. Press the “Input” key for 0.5 seconds or longer to display the Input Source menu. Press the ▲/▼ keys to change the input source to iOS. Then press the “Display/Enter” key.
3. Configure the router connection settings in the “Setup” > “Wifi Setting” > “Internet” menu. Configure the connection settings to the router also on your iOS device.
4. Press the “Display/Enter” key to display the screen. If the connection to the iOS device has not been established, the Device Name and Password message will appear on the top left corner of the screen.
5. Swipe up from the bottom of the iOS screen to open the Control Center. Tap on “Screen Mirroring”.
6. Tap on the connected ImagePointer to start the screen mirroring.

Basic Operations

Powering On the Projector and Connecting to the Android Device (Direct Connection)

Note

❖ Press the “Input” key for 0.5 seconds or longer to display the Input Source menu.

❖ The instructions described in this section may vary depending on the Android version. To learn how to use your Android device, please refer to the operating instructions that came with the device.

❖ Before using the screen mirroring, ensure that your Android device supports Miracast. Without Miracast support, the screen mirroring is not possible.

1. Turn on the projector by pressing and holding the “Power” key for 1 second or longer.
The power LED around the “Power” key will turn blue and the RICOH logo will be displayed on the screen for 20 seconds. After that is displayed a blank screen.
2. Press the “Input” key for 0.5 seconds or longer to display the Input Source menu. Press the ▲/▼ keys to change the input source to Android. Then press the “Display/Enter” key.
3. Press the “Display/Enter” key again to display the screen. If the connection to the Android device has not been established, the Device Name and Password message will appear on the top left corner of the screen. (Figure 7)
4. Swipe down from the top of the Android device screen to open the quick settings panel. Tap “Smart View”. Select the Device name that is displayed on the screen, and tap “Start now”. (Figures 8~10)
5. When the connection status appears (Figure 11), then the screen mirroring starts.



Figure 7

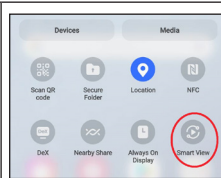

Figure 8

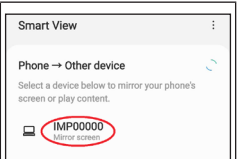

Figure 9

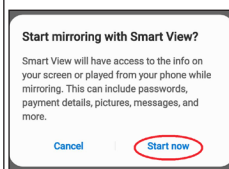

Figure 10



Figure 11

Powering Off the Projector

1. Press and hold the “Power” key for 2 seconds to turn off the projector. You will see a message as below on the screen.



If you wish to turn the projector back on, you must wait until the projector has entered the standby mode. When it is in standby mode, simply press “Power” to restart the projector.

2. Disconnect the USB-C cable from the projector.

Warning Indicator

- ❖ When the LED indicator flashes red and blue (0.1 sec on / 0.1 sec off / 0.1 sec on / 0.1 sec off / 0.1 sec on / 0.5 sec off) and the message below displays onscreen, it indicates the projector has overheated. Ensure that the ambient temperature is within operating range. If the problem persists, please contact the vendor.



Basic Operations

- ❖ When the LED indicator flashes red and blue (0.1 sec on / 0.1 sec off / 0.1 sec on / 0.1 sec off / 0.1 sec on / 0.1 sec off / 0.1 sec on / 0.3 sec off) and the message below displays onscreen, it indicates an internal error has occurred. Restart the projector. If the problem persists, please contact the vendor.

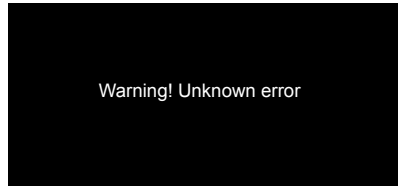

- ❖ When you press the "Power" key for 2 seconds or more, the following error is displayed on the screen.

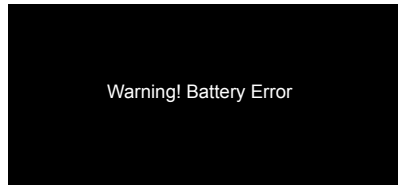

- When the Power LED lights red for 10 seconds, the power is turned off. To turn on the projector, wait until the Power LED turns off. Then press the "Power" key again.
- Disconnect the USB type-C cable from the projector and from the power adapter.

Basic Operations

Adjusting the Projector Focus

To adjust the focus, turn the focus ring clockwise or counterclockwise until the image is sharp and legible.

- ▶ The projector will focus at distances from 1.96 to 6.43 feet (0.6 to 1.96 m).

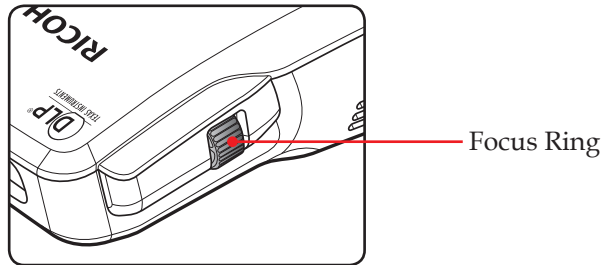

Adjusting Projection Image Size

- ▶ Projection Image Size from 25" to 80" (63.5 to 203.2 cm).

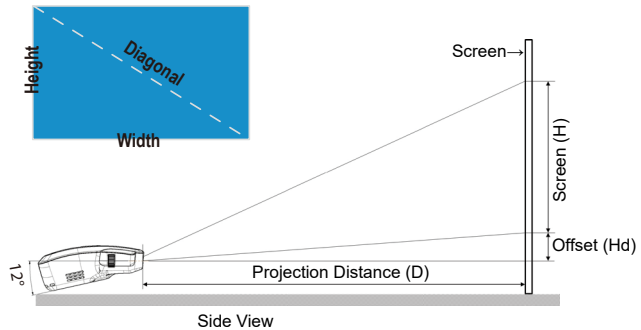

Diagonal (inch)	Distance D (m)	Screen Width	Screen Height H (m)
25	0.61	0.55	0.31
30	0.73	0.66	0.37
40	0.97	0.89	0.50
50	1.22	1.11	0.62
60	1.46	1.33	0.75
80	1.96	1.77	1.00

User Settings

On Screen Display (OSD)

The Projector has a multilingual On Screen Display that allows you to make image adjustments and change a variety of settings.

How to operate

1. To open the OSD, press the “Menu” key for 0.5 seconds or longer.
2. To select an item, press the ▲ or ▼ keys and then press ←.
3. To adjust settings, press the ▲ / ▼ or ► / ◀ keys.
4. Press the “Menu” key once to return to the previous menu or press the “Menu” key repeatedly to exit the OSD menu.

Note

❖ The projector has a multi-language onscreen display (OSD) menu that can be displayed with or without an input source.

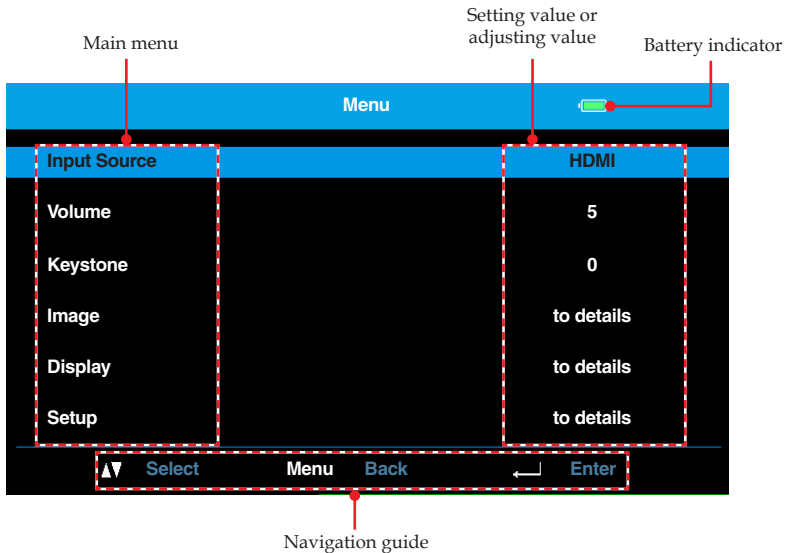

User Settings

Menu Tree

Main Menu	2nd Level	3rd Level	4th Level
Input Source	HDMI (default)		
	Android		
	iOS		
Volume			0-10 (default: 5)
Keystone			-20~20 (default: 0)
Image	Sub Menu	Picture Mode	Standard (default)
			Photo/Movie
			Vivid
		Brightness	0-50 (default: 25)
		Contrast	0-50 (default: 25)
		Aspect Ratio	Auto (default)
			4:3
			16:9
			16:10
		Color Temperature	Cold
			Medium (default)
			Warm
		Color Space	Auto (default)
RGB			
YCbCr			
Display	Sub Menu	Projection	Normal (default)
			H Flip
			V Flip
			HV Flip
		Keep Projection	While pressing (default)
			1 click
			Double click
			5sec Later
			All times

User Settings

Main Menu	2nd Level	3rd Level	4th Level
Setup	Sub Menu	Language	Japanese (default)
			English
			Germany
			French
			Italian
			Spanish
			Portuguese
			Polish
			Dutch
			Russian
			Swedish
			中文(繁)
			中文(簡)
			Turkish
			Thai
			Arabic
		Danish	
		Sleep timer	Off
			5
			10 (default)
			15
		Wifi Setting	Internet
			Password
			Device Name
			5GHz On/Off
		User Logo	Follow UI Flow
		Software Ver.	
Reset	Yes/No		

User Settings

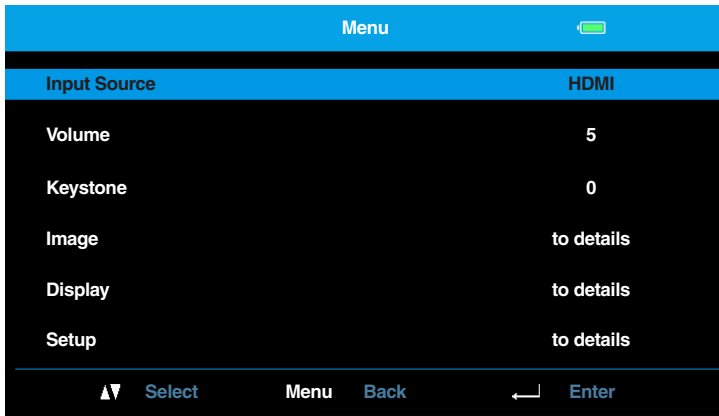

Main Menu

Input Source

Set the input source.

- ▶ HDMI: Set HDMI as input source.

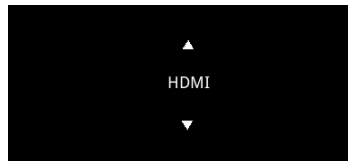

- ▶ Android: Connect to your Android device via WiFi.

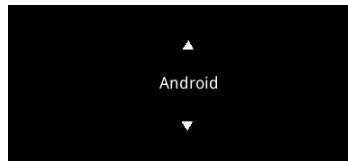

- ▶ iOS: Connect to your iOS device via WiFi.

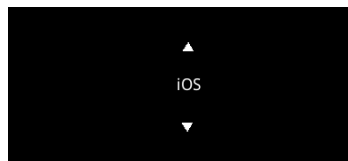

User Settings

Volume

Adjust the volume.



- ▶ Press the ▲ key to turn up the volume (up to 10).
- ▶ Press the ▼ key to turn down the volume (minimum value 0).

Keystone

Manually adjust image distortion caused by tilting the projector.

Image

Go to “Image” sub menu.

Display

Go to “Display” sub menu.

Setup

Go to “Setup” sub menu.

User Settings

Image 	
Picture Mode	Standard
Brightness	25
Contrast	25
Aspect Ratio	Auto
Color Temperature	Medium
Color Space	Auto

▲▼ Select Menu Back ↩ Enter

Image Menu

Picture Mode

There are factory presets optimized for various types of images.

- ▶ Standard: Mode for optimizing the balance between brightness and color reproduction. Suitable for PC screen display and presentation.
- ▶ Photo/Movie: This mode brings the color reproduction space closer to sRGB. You can project photos and movies in colors close to their original colors.
- ▶ Vivid: Mode for emphasizing color.

Brightness

Adjust the brightness of the image.

- ▶ Press the ▲ to increase the brightness of the screen (up to 50).
- ▶ Press the ▼ to reduce the brightness of the screen (minimum value 0).

Contrast

Adjust the contrast.

- ▶ Press the ▲ to increase the contrast of the screen (up to 50).
- ▶ Press the ▼ to decrease the contrast of the screen (until 0).

User Settings

Aspect Ratio

Use this function to choose your desired aspect ratio.

- ▶ Auto: The projector displays the image by automatically switching the screen sizes between 4:3 and 16:9.
- ▶ 4:3: Input signal is displayed with 4:3 aspect in the center of the screen.
- ▶ 16:9: Input signal is displayed with 16:9 aspect in the center of the screen. This mode is for 16:9 aspect signals.
- ▶ 16:10: This format is for 16:10 input sources, like wide screen laptop.

Color Temperature

Select the color temperature.

- ▶ Cold: The screen image looks colder.
- ▶ Medium: The medium color temperature.
- ▶ Warm: The screen image looks warmer.

Color Space

Select an appropriate color matrix type from "Auto", "RGB", and "YCbCr".

Note

❖ The "Color Space" function is supported only in HDMI mode.

User Settings

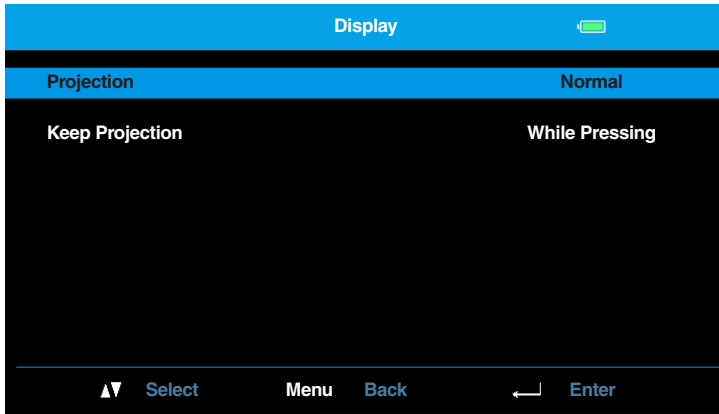

Display

Projection

Select the projection mode, depending upon how the projector is mounted. The options include "Normal", "H Flip", "V Flip", and "HV Flip".

Keep Projection

Select how the "Display/Enter"  key should be pressed to keep continuous projection. The options include "While pressing", "1 click", "Double click", "5sec Later", and "All times".

User Settings

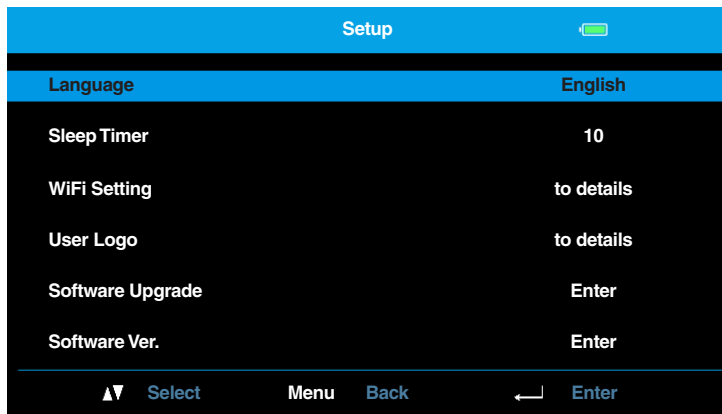

Setup	
Language	English
Sleep Timer	10
WiFi Setting	to details
User Logo	to details
Software Upgrade	Enter
Software Ver.	Enter

▲▼ Select Menu Back ↩ Enter

Setup

Language

The language used in the onscreen Menu is available in English, Germany, French, Italian, Spanish, Portuguese, Polish, Dutch, Russian, Swedish, Traditional Chinese, Simplified Chinese, Japanese, Turkish, Thai, Arabic, and Danish.

Sleep Timer

Set the countdown timer interval between “5”, “10”, “15”, or “Off”. The countdown timer will start, without signal being sent to the projector and without OSD operation. The projector will automatically power off when the countdown has finished.

WiFi Setting

Go to “WiFi Setting” sub menu.

User Logo

Set the background image that is displayed on the screen when there is no input signal. In the list of background images, press the ◀ and ▶ keys to select your preferred image. Then press the “Display/Enter” key. The selected background image is displayed on the screen until the projector detects the signal input. To save a background image, go to page 37.

User Settings

Software Upgrade

Search for software upgrade online. Wait until the upgrade process is complete.

Note

❖ Before upgrading the software, ensure that the projector has access to the Internet and the internal battery is fully charged. If not fully charged, the upgrade process stops and the projector displays the following message on the screen:

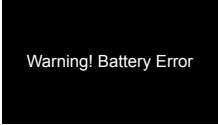

Warning! Battery Error

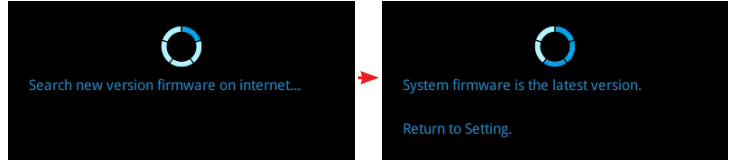

Software Ver.

View the current projector's firmware version.

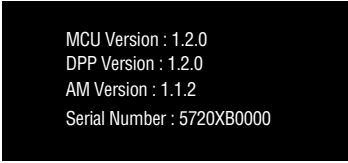

MCU Version : 1.2.0
DPP Version : 1.2.0
AM Version : 1.1.2
Serial Number : 5720XB0000

Reset

Return all data to the factory defaults. After choosing this option, a confirmation message appears on the screen. Select "Yes" to confirm or "No" to cancel reset.

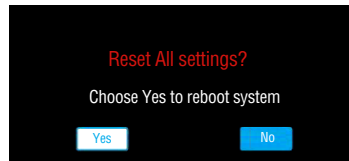

User Settings

WiFi Setting



Internet

Note

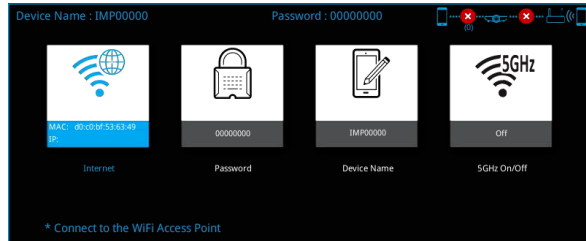
❖ To start wireless screen casting, connect your portable device and the projector to the same wireless access point.



To connect the projector to the WiFi, do the following:

1. Open “Menu” > “Setup” > “WiFi Setting” and press “Display/Enter”  on the control panel.
2. Select the “Internet”  tab.
3. Do either of the following:
 - Select your preferred wireless access point from the list to make the connection. If the WiFi is password-protected, enter the password at the prompt. Then press the “Menu” key to close the onscreen keyboard, and press “OK”.



Note

❖ The default device name is “IMPXXXXX” where the “XXXXX” are the five last numbers of the product Serial Number. For example, “IMP00099”.

- If the wireless access point is not available, connect your portable device directly to the projector’s hotspot. The WiFi name (Device Name) and the password (Password) are displayed on the Internet tab.

User Settings

Password

Note

❖ The default password is "00000000".

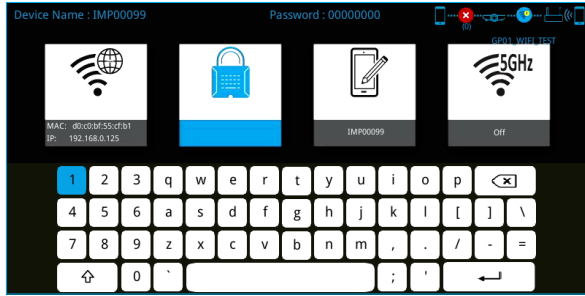

To set an access password for the projector, do the following:

1. Open "Menu" > "Setup" > "WiFi Setting" and press "Display/Enter" ↵ on the control panel.
2. Select the "Password" 🔒 tab.
3. Use the onscreen keyboard to enter a password that contains numbers and/or letters up to 8 symbols. When the password is set, click ↵.

Device Name

Note

❖ The default device name is "IMPXXXXX" where the "XXXXX" are the five last numbers of the product Serial Number. For example, "IMP00099".

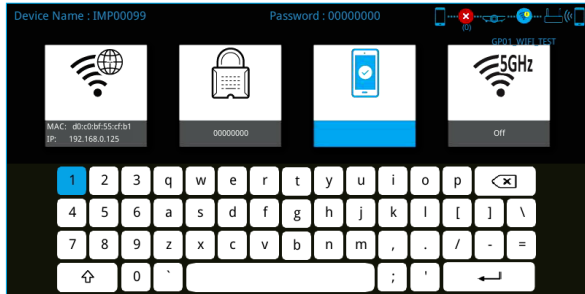

To change the default projector name, do the following:

1. Open "Menu" > "Setup" > "WiFi Setting" and press "Display/Enter" ↵ on the control panel.
2. Select the "Device Name" 📱 tab.
3. Use the onscreen keyboard to enter a new name. The name can contain numbers and/or letters up to 10 symbols. When the name is changed, click ↵.

Note



❖ After resetting the system (Setup > Reset), the device name and password are also reset to the default values.

User Settings

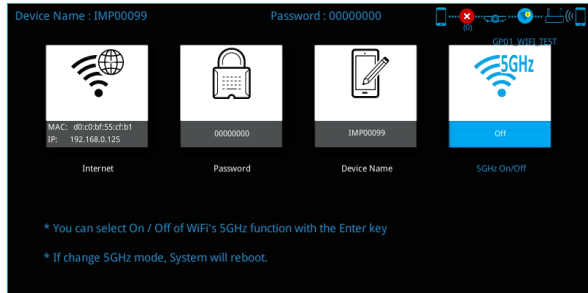
5GHz



Enable or disable 5GHz communication. By default, 5GHz is off (5GHz radio waves are disabled). If 5GHz is available in your area, and you want to enable this function, do the following:

1. Open "Menu" > "Setup" > "WiFi Setting" and press "Display/Enter"  on the control panel.
2. Select the "5GHz"  tab.
3. Press the  to enable 5GHz bandwidth.

User Settings

User Logo Setting

You can add/display a background image on the screen if there is no input signal. The User Logo image must be in Jpeg format. If you want to display the image in a full screen, make sure the image size is 864x480 pixels. To download an image, connect the projector directly to the PC or any other compatible device. When connecting directly, set the input source to “HDMI” or “iOS”.

Note

- ❖ To set the User Logo, go to page 32.
- ❖ Only images in Jpeg format can be used as logos.
- ❖ The maximum image size for baseline Jpeg is 8000 x 6000 pixels and for progressive Jpeg is 1600 x 1200 pixels.
- ❖ Up to 11MB of User Logo images are allowed to upload.
- ❖ The image file name cannot contain the following characters: \/:?*“<>|.

Download images from a Windows PC:

1. Connect the projector to the Windows PC via WiFi.
2. Open the File Explorer and type “ftp://192.168.168.1” to the address bar. When prompted, enter the User Name and Password as they appear in the User Logo menu.
3. Click “Log On” and access the User Logo folder. (Figures 1~3)

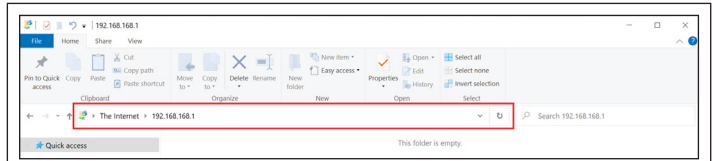

Figure 1

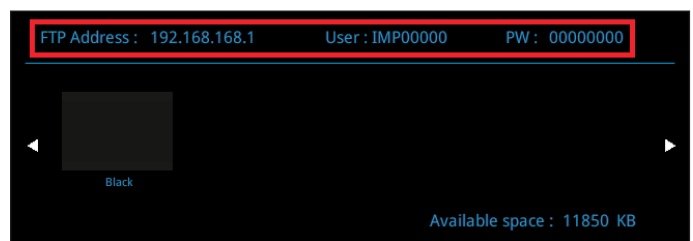

Figure 2

Troubleshooting

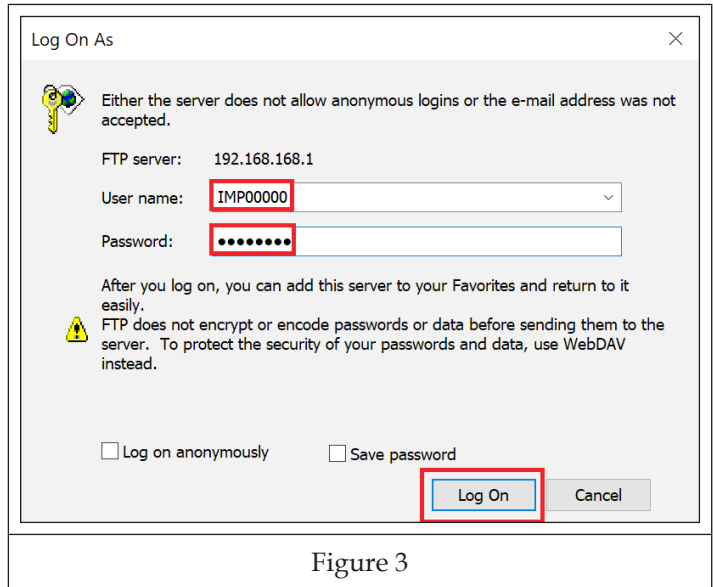

Figure 3

3. Copy and paste the image to the User Logo folder. The image appears in the User Logo menu. The Available Size will decrease after the image is uploaded. (Figures 4~5)
4. When the upload is complete, close the WiFi connection between the projector and the Windows PC.

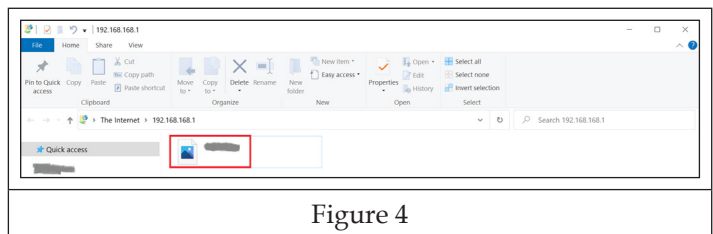

Figure 4

Note

❖ Only images in Jpeg format can be used as logos.

❖ The maximum image size for baseline Jpeg is 8000 x 6000 pixels and for progressive Jpeg is 1600 x 1200 pixels.

❖ Up to 11MB of User Logo images are allowed to upload.

❖ The image file name cannot contain the following characters:
\\/:?*'"<>|.

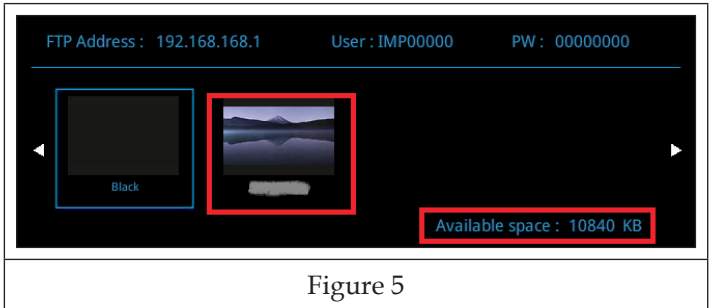

Download images from an iOS device:

1. Connect the projector to the iOS device via WiFi.
2. Start the File Transfer Protocol (FTP) app on your iOS device, for example "iFTP Pro".
3. Open the iFTP Pro app, tap "+" to add a new FTP site. Enter the Hostname "192.168.168.1", Username and Password as displayed in the User Logo menu, Port: "21", Protocol: "FTP". Tap "Save" to save the new FTP site. (Figures 6~8)
4. Tap on the new FTP site and access the User Logo folder. (Figure 9).
5. Your images from the iOS device are displayed on the bottom of the screen in Photo Library folder. Select the images you want to upload to the projector. When done, tap "Done". (Figures 10~11)
6. When the upload is complete, close the WiFi connection between the projector and your iOS device.

Troubleshooting

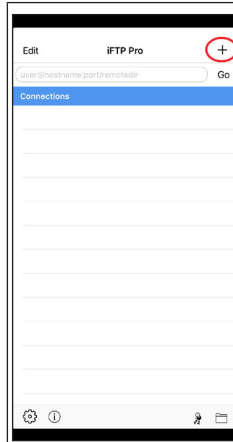

Figure 6



Figure 7

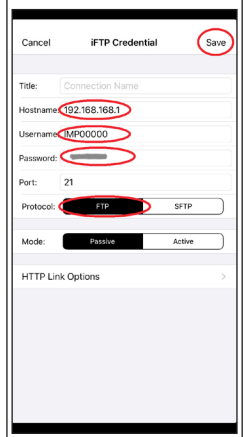

Figure 8

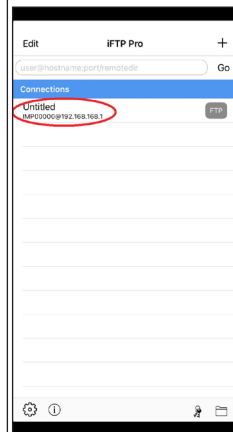

Figure 9

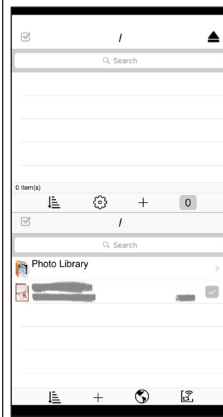

Figure 10

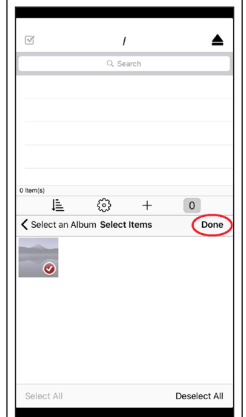

Figure 11

Download an image from an Android device:

1. Connect the projector to the Android device via WiFi. On the Android device, select "Settings" > "WiFi". Then tap on the projector name and enter the password.
2. Start the file manager app on your Android device, for example "File Manager".
3. Open the File Manager app and tap on "Remote". (Figure 12).
4. Tap on "Add a remote location". (Figure 13)
5. Tap on "FTP". (Figure 14).
6. Enter the Hostname: "192.168.168.1", Port: "21", Username and Password as displayed in the User Logo menu. Then tap "OK".(Figures 15)
7. On the home page of the File Manager, ensure that under "Remote" tab is "(1)", indicating that adding a new FTP site was successful. (Figure 16)
8. Select the images you want to upload to the projector from any folder (usually "Images" folder). (Figure 17)
9. Long press on the image you want to transfer. A menu appears on the bottom of the screen. Tap on "Copy". (Figure 18)
10. Return to the Home page of the File Manager and tap on "Remote" to enter the FTP site. Then tap on "Paste" at the bottom of the screen. (Figure 19)
11. The image transfer starts. (Figure 20)
12. When the upload is complete, close the WiFi connection between the projector and your Android device.

Note

❖ Only images in Jpeg format can be used as logos.

❖ The maximum image size for baseline Jpeg is 8000 x 6000 pixels and for progressive Jpeg is 1600 x 1200 pixels.

❖ Up to 11MB of User Logo images are allowed to upload.

❖ The image file name cannot contain the following characters:
\\/:?*'"<>|.

Troubleshooting

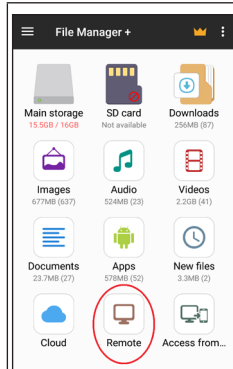

Figure 12

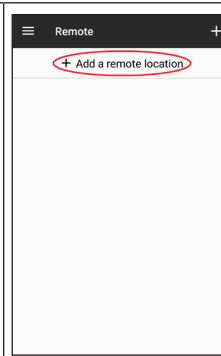

Figure 13

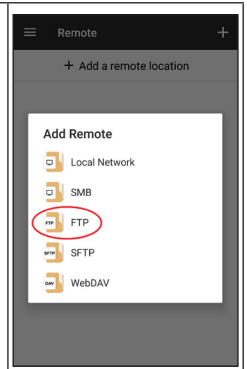

Figure 14

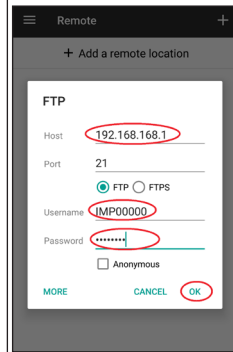

Figure 15

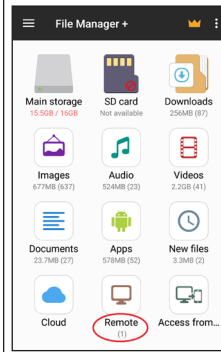

Figure 16

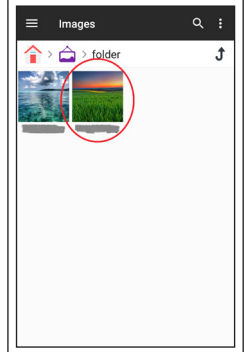

Figure 17

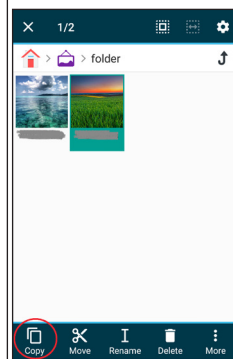

Figure 18

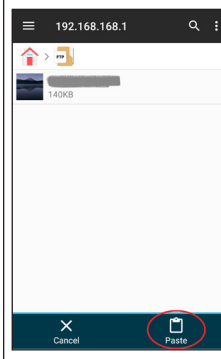

Figure 19

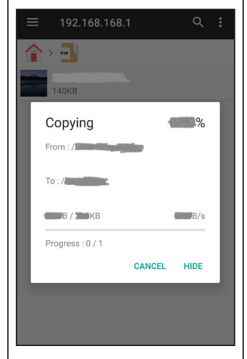

Figure 20

Troubleshooting

If you experience trouble with the projector, refer to the following information. If the problem persists, please contact your local dealer or service center.

Problem: No image appears on screen

- ▶ Ensure that the power connection is correctly and securely connected as described in the “Connecting the Projector” section.
- ▶ Ensure that the terminals are not crooked or broken.
- ▶ Ensure that the power of the connected device is turned on.
- ▶ Ensure that the projector is in the projection mode. Press the “Display/Enter” key and check if the image appears on the screen.
- ▶ Ensure that the connected device is not in the standby mode.

Problem: Partial, scrolling or incorrectly displayed image

- ▶ If you are using a Notebook:
 1. First, follow the steps above to adjust resolution of the computer.
 2. Press the toggle output settings.

For example in Windows system, press “Windows key” + “P”.
- ▶ If you experience difficulty changing resolutions or your monitor freezes, restart all equipment including the projector.

Problem: The screen of the Notebook or PowerBook computer is not displaying a presentation

Some Notebook PCs may deactivate their own screens when a second display device is in use. Each has a different way to be reactivated. Refer to your computer’s documentation for detailed information.

Problem: Image is unstable or flickering

- ▶ Change the monitor setting from your computer.
- ▶ Check and reconfigure the display mode of your graphic card to make it compatible with the product.

Problem: Image is out of focus

- ▶ Adjust the Focus Ring on the projector.
- ▶ Make sure the projection screen is between the required distance. Please see page 23.

Problem: The image is stretched when displaying 16:9 DVD

Change “Aspect Ratio” by pressing the “Menu” key on the control panel and change the image format in “Menu” > “Image” > “Aspect Ratio”.

Problem: Image is too small or too large

- ▶ Move the projector closer to or further from the screen.
- ▶ Press “Menu” key on the control panel and then go to “Menu” > “Image” > “Aspect Ratio” and try the different settings.

Problem: Image is reversed





- ▶ Press “Menu” key on the control panel and then go to “Menu” > “Display” > “Projection” and adjust the projection direction.

Problem: Projector turned off with power adapter



- ▶ Ensure the power adapter output is 5V/2A or higher.
- ▶ Ensure the environmental temperature is in the range of 32° to 86°F (0° to 30°C).

Troubleshooting

Problem: Indicator lighting message

Message	LED Indicator (Red/Blue)
Battery Charging	Slowly flashing (Red) (2 sec On/1 sec Off)
Power On (Battery Power: 25%~100%)	Lights  (Blue) when the power is turned on Turns off  when you start projecting Lights  (Blue) again when you stop projecting
Power On (Battery Power: 5%~25%)	Flashing (Blue) (1 sec On/1 sec Off)
Power On (Battery Power: <5%)	Flashing (Blue) (0.2 sec On/1 sec Off)
Battery Error	Flashing (Blue/Red) (0.1 sec On/0.1 sec Off/ 0.1 sec On/0.7 sec Off)
Thermal Error	Flashing (Blue/Red) (0.1 sec On/0.1 sec Off/ 0.1 sec On/0.1 sec Off/ 0.1 sec On/0.5 sec Off)
Internal Error	Flashing (Blue/Red) (0.1 sec On/0.1 sec Off/ 0.1 sec On/0.1 sec Off/ 0.1 sec On/0.1 sec Off/ 0.1 sec On/0.3 sec Off)
Projecting, power off, or finished charging	

Note

Steady light => 
No light => 

Problem: Message Reminders

- ▶ Over temperature (flashing purple, lights up 3 times per second)
 - The ambient temperature is too high or other items are covering the projector. Please avoid using the projector until it cools down. If the environmental temperature is normal and the over temperature warning appears too often, please take the projector to the service.



Warning! Temperature too High

- ▶ Internal error - restart the projector. If the problem persists, please take the projector to the service.

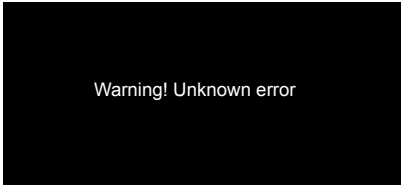

Warning! Unknown error

- ▶ Battery error - Please take the projector to the service.

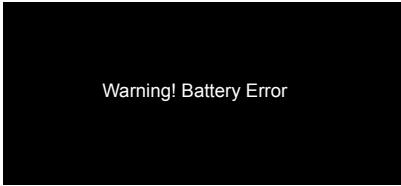

Warning! Battery Error

- ▶ Projector is unresponsive:
 - The internal battery may be depleted. Plug in the power adapter and make sure the LED indicator starts flashing red.

Appendices

List of Compatible Signals

HDMI Digital				
Modes	Resolution	V.Freq (Hz)	H.Freq (KHz)	Remarks
(1) PC Signal				
VGA	640 x 480	60	31.5	Established Timings 1
SVGA	800 x 600	60	37.9	Established Timings 1
	854 x 480	60	29.7	Detail Timing 1 (Block0)
XGA	1024 x 768	60	48.4	Established Timings 2
SXGA	1280 x 1024	60	64	Standard Timing 5
QVGA	1280 x 960	60	60	Standard Timing 4
SXGA+	1400 x 1050	60	65.3	Standard Timing 3
	1920 x 1080	60	67.5	Standard Timing 1
(2) Extended Wide Timing				
WXGA	1280 x 720	60	44.8	Detail Timing (Block 1)
	1280 x 800	60	49.6	Standard Timing 6
	1440 x 900	60	55.9	Standard Timing 7
WSXGA+	1680 x 1050	60	65.3	Standard Timing 8
(3) Component Signal				
480i	720(1440) x 480	59.94	15.7	Short Video
576i	720(1440) x 576	50	15.6	Short Video
480p	640 x 480	59.94	31.5	Short Video
	720 x 480	59.94	31.5	Short Video
576p	720 x 576	50	31.3	Short Video
720p	1280 x 720	60	45	Short Video
	1280 x 720	50	37.5	Short Video
1080i	1920 x 1080	60	33.8	Short Video
	1920 x 1080	50	28.1	Short Video
1080p	1920 x 1080	23.98/24	27	Short Video
	1920 x 1080	60	67.5	Short Video

Appendices

WiFi Standard		
IEEE 802.11	n	○
	ac	○

Note

Supported => ○

Indoor use only => ⊙

Not allowed => X

WiFi Frequency and Channel				
Frequency	Channel	GP01		
		JP	NA	EU
2.4GHz	1~11	⊙	⊙	⊙
	12~13	⊙	X	⊙
	14	X	X	X
5.2GHz	36	○	⊙	○
	40	○	⊙	○
	44	○	⊙	○
	48	○	⊙	○
5.3GHz with DFS/TPC	52	X	X	X
	56	X	X	X
	60	X	X	X
	64	X	X	X
5.6GHz with DFS/TPC	100	X	X	X
	104	X	X	X
	108	X	X	X
	112	X	X	X
	116	X	X	X
	120	X	X	X
	124	X	X	X
	128	X	X	X
	132	X	X	X
	136	X	X	X
140	X	X	X	
5.8GHz	149	X	⊙	X
	153	X	⊙	X
	157	X	⊙	X
	161	X	⊙	X
	165	X	⊙	X

Appendices

Note

Supported => O
Not supported => X

Communication Mode				
Mode	GP01			Remarks
	JP	NA	EU	
Miracast	O	O	O	Compliant with Android
Airplay	O	O	O	Compliant with AirPlay
PC connect via AP	X	X	X	
Adohoc	X	X	X	

Network Authentication			
Item	GP01		
	JP	NA	EU
Open System	O	O	O
WPA/WPA2-PSK	O	O	O
WPA2-PSK	O	O	O
WPA/WPA2-EAP	X	X	X
WPA2-EAP	X	X	X

Wireless Security			
Encryption	JP	NA	EU
(None)	O	O	O
WEP	X	X	X
TKIP/COMP(AES)	O	O	O
WPA2	O	O	O

Appendices

Specifications

■ List of general specifications

Item		Specification
Projection System		TI DLP® FWVGA chip
Resolution		FWVGA (854 x 480)
LED		LED, Osram KR/KP/KB CSLNMI
LED Life		20,000 Hours
Lens		F#1.7, fl=5.02 mm (at 40" screen)
Focus		Manual
Projection Distance		0.6 ~ 1.96m
Projection Screen Size		25 ~ 80 inch
Throw Ratio		1.1
Dimensions (WxHxD)		69.8x111.0x38.0 mm (excluded protruding parts)
Weight		205g ± 10g (0.45lbs)
Connection terminal	HDMI- in Connector	HDMI 1.4
	USB Type-C Power Connector	Power in (DC 5V/2A, charging only)
Wireless Communication	Mirroring Compatible OS	Android, iOS
	Frequency	2.4 GHz/5 GHz
	Standard	IEEE 802.11n/ac
Speaker	1W (Mono)	
Power Consumption	Less than <1mW (power off) / 10W (maximum)	
Environmental Considerations	Operational Temperatures : 32° to 95°F (0° to 35°C), 0% to 80% humidity (non-condensing) Storage Temperatures : -22° to 149°F (-30° to 65°C), 0% to 90% humidity (non-condensing)	

Note

- Designs and specifications are subject to change without notice.
- This model may not be compatible with features and/or specifications that may be added in the future.

Dispose of the Projector

Note

For disposal of used battery, follow local ordinance and/or regulation.

This projector uses a lithium-ion battery. When disposing of the projector, follow the procedure below to remove the lithium-ion battery from the device. Remove the battery also if you are not going to use the projector for an extended period of time.

To remove the internal battery, you need the following tools:

- Precision screwdriver set
- A pair of vinyl gloves

To remove the battery, do the following:

1. Discharge the battery. To discharge, turn on the projector and leave it idle until the battery depletes and the power turns off. Wait until the projector cools down sufficiently.
2. Separate the top and bottom covers of the projector.
 - a) Using a precision screwdriver, remove the two screws from the bottom cover.

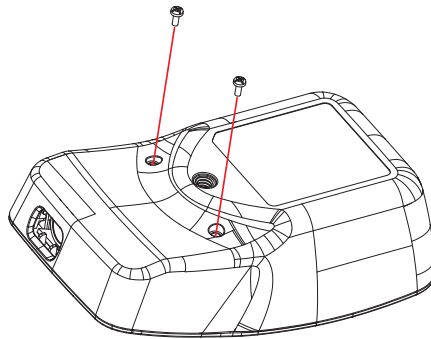

Appendices

- b) Pry open the upper and bottom covers near the lens. Using a flat-head screwdriver, work around the edges of the bottom and top cover to undo the plastic clips.

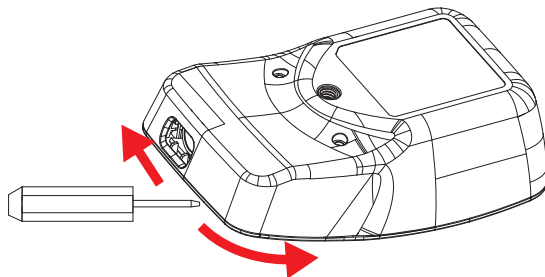

3. Remove the bottom cover.

- a) While holding the top cover, remove the bottom cover from the device.

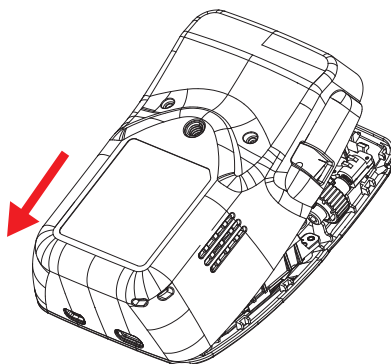
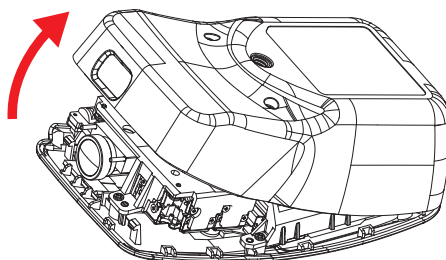

Appendices

4. Remove the battery. The battery is installed on the bottom side of the projector. Disconnect the battery cable and then remove the battery.

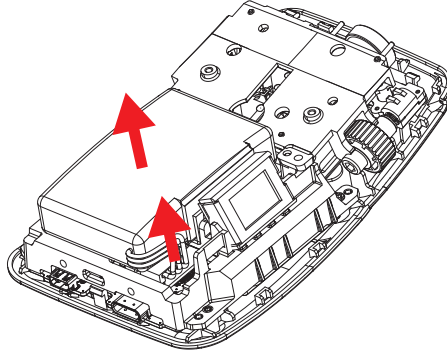

Cabinet Dimensions

Unit: mm

Refer to the image below for the location of the screw holes.

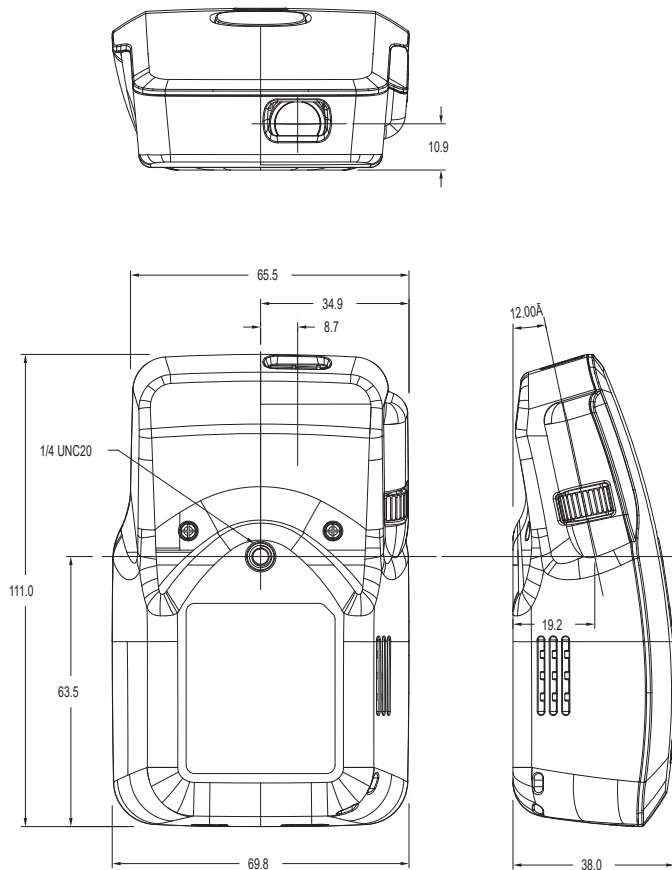

Hole for ceiling mount
Size: 1/4"-20

Trademarks

- DLP is trademarks of Texas Instruments.
- HDMI, the HDMI Logo and High-Definition Multimedia Interface are trademarks or registered trademarks of HDMI Licensing Administrator, Inc.
- IBM is a trademark or registered trademark of International Business Machines Corporation.
- Macintosh, Mac OS X, iMac, PowerBook, AirPlay, and Apple TV are trademarks of Apple Inc., registered in the U.S. and other countries.
- iOS trademark is used under license from Cisco U.S.A.
- Microsoft, Windows, Windows Vista, Internet Explorer and PowerPoint are either a registered trademarks or trademarks of Microsoft Corporation in the United States and/or other countries.
- Google, Google Play, Android, YouTube, Gmail are trademarks or registered trademarks of their respective owners.
- HDMI, the HDMI Logo and High-Definition Multimedia Interface are trademarks or registered trademarks of HDMI Licensing LLC.
- Wi-Fi, Wi-Fi CERTIFIED Miracast[®], and Miracast[®] are the members of the Wifi Alliance.
- Blu-ray is a trademark of Blu-ray Association.

Appendices

- USB Type-C and USB-C are trademarks of USB Implementers Forum, Inc..
- Other product and company names mentioned in this user's manual may be the trademarks or registered trademarks of their respective holders.

Copyrights

This projector uses open source and/or third party software. To check the information about software copyrights. You can also view and download the source code from:
http://www.support-download.com/bb/html/dr_ut_e/oss/index.htm



